

Instruction Manual Flask-Sampler

Version: 0.9



Table of contents

1.	Safety notes	5
2.	Intended use	6
3.	Technical data	6
4.	Package Content	7
5.	Unpacking and build up	8
5.1.	Install monitor mount (optional)	9
6.	The device.....	10
6.1.	Overview	10
6.2.	Location	11
6.3.	Connections.....	11
7.	Insert and remove flasks	14
7.1.	Prepare flask ports	14
7.2.	Insert flask (physically)	15
7.3.	Insert and remove flask procedure.....	16
7.4.	Sampler ready for sampling self-test	17
8.	Software.....	18
8.1.	Overview	18
8.2.	Sampler Overview	19
8.3.	Plumbing Overview	23
8.4.	Packing tool.....	25
8.5.	Sample keeper & group tool	26
8.6.	Sensor plot	27
8.7.	Log View	28
8.8.	Settings & flask list & activities.....	29
8.9.	drying Unit	31
8.10.	Advanced trigger settings.....	33
8.11.	Advanced flow schemes	35
8.12.	Time line plot	36
9.	Filling methods	37
10.	Sampling example	38
11.	Maintenance	39
12.	Troubleshooting	41
12.1.	Frequent faults	41
12.2.	Locate the leak.....	41
13.	Spare part list / consumables	42
14.	Contact.....	43
	APPENDIX.....	44
I.	Color coding drawer front	44
II.	Blink coding	44
III.	Barcodes	44

1. Safety notes



Danger of glass breakage in connection with overpressure (safety equipment: eye protective goggles)!



Risk of injury from motorized valves (shearing, squeezing)!



Electric shock (before opening the device - pull main electricity plug)!
Opening the device may only be carried out by qualified personnel!



Risk of tipping when several drawers are opened at the same time (The device must be fixed to the wall by suitable means)!
Rollers must be locked during operation.



The device may only be used indoor!



Repairs may only be carried out by the manufacturer or by qualified personnel!



The sample air must not contain any solid, liquid or combustible substances as these can impair the function of the pumps and valves!



The device may only be used in a technically perfect condition, observing the instruction manual.



The device may only be operated by trained and instructed personnel!
This applies in particular to assembly, connection and maintenance work!

2. Intended use

The Flask-Sampler is used for the automated collection of air samples under standardized conditions. Only one, two and three liter flasks from Normag (NORMAG Labor- und Prozesstechnik GmbH) with gear-wheel connection (Item number: ICOS1000, ICOS2000, ICOS3000) are to be used. The device must be operated at a fixed location within a building. The air introduced must be dry (dew point < -35°C).

3. Technical data

Dimensions und weight

length:	0,60 m
width:	1,00 m
height:	1,60 m
weight:	< 200 Kg

Performance data

power supply	230 V AC / 50 Hz
current consumption	≤ 6,3 A
protection class (EN 61140)	IP 20
max. system pressure	2,0 bar(a) over pressure
max. inlet pressure	2,0 bar(a) (shall not be exceeded)

Environmental conditions

ambient temperature	5 °C to 30 °C
relative humidity	up to 80 %

4. Package Content

- ICOS Flask Sampler
- 10x drawer transportation lock (attached at delivery)
- barcode scanner (Datalogic QuickScan Lite QW2120)
- mouse (Logitech B100)
- keyboard (Logitech K120)
- monitor 24" 1920 x 1200 (Dell U2415)
- spiral wrap with DVI/HDMI cable 3m and usb cable 3m
- power cord 3m - monitor
- power cord 1m - flask sampler
- 2x safety goggles
- 10x spring plungers with counter nuts
- 48x flask ports sleeves (48x blind plugs are already inserted)
- CAN terminating resistor (120 Ω)

- monitor mount (optional)
 - monitor mount
 - keyboard plate
 - mouse pad (with ICOS label)
 - hook-and-loop tape
 - 2x M8x16 hexagon socket screw and 2x T-Nut
 - 4x M4x10 hexagon socket screw (VESA mount)
 - 2x M6x13 countersunk screws and 2x nut (keyboard plate)

5. Unpacking and build up

! Read this instruction manual before first use and unpacking!

! Never open more than one drawer at once!

1. check if the tilt and shock indicators have tripped - Figure 1
2. if existing: screw off the ICOS CAL own Transport Data Logger from the shipping container and send it back to: "ICOS, Kahlaische Straße 4, TCF Eingang C, D-07745 Jena, Germany" - Figure 2
3. open the shipping container - Figure 2
4. take out small boxes and stuff and put it aside
5. lift sampler from the box stand
6. open ratchet from tie down straps and carefully take off wooden plate.
7. detach safety foil from acrylic glass panes
8. open each drawer and remove all rubber bands (transportation lock)
9. open each drawer, insert and adjust spring plungers with a 19 mm spanner. You need to hear a dulcet click sound when the drawer is closed - Figure 3
10. replace blind plugs with sleeves at every flask port - Figure 4
11. connect all cables and tubes (⇒ 6.3)



Figure 1: shock and tilt indicator



Figure 2: Bosch Transport Logger front/back view



Figure 3: opened shipping container

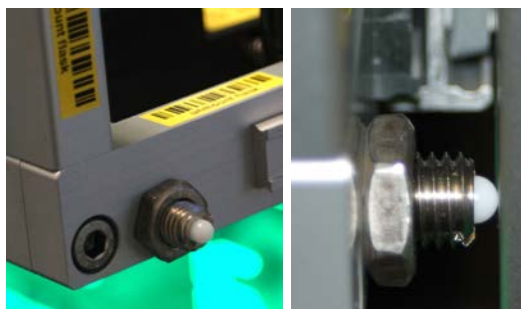

Figure 4: insert and adjust spring plungers



Figure 5: replace blind plugs with sleeves

5.1. Install monitor mount (optional)

1. connect keyboard plate with monitor mount (use 2x M6x13 countersunk screws and 2x nut)
2. insert 2x T-nuts (M8) into the notch of the left or right aluminum profile of the case
3. attach the monitor mount to the flask sampler case (use 2x M8x16)
4. attach the monitor to the monitor mount (use 4x M4x10)
5. use adhesive hook-and-loop tape to fix the keyboard to the keyboard plate
6. connect all cables (3m power cord, 3m DVI/HDMI cable, 3m USB cable)



Figure 6: connect keyboard plate and monitor mount



Figure 7: attach the monitor

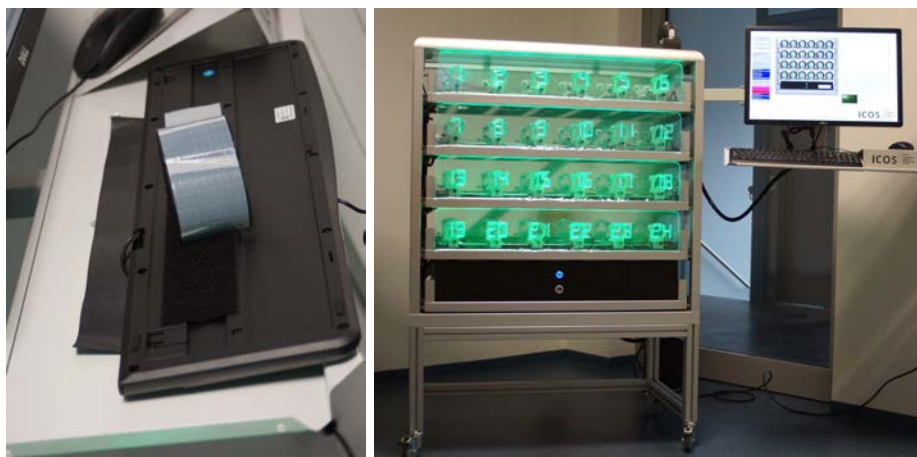

Figure 8: fix the keyboard and connect all cables

6. The device

6.1. Overview

The Flask-Sampler consists of five drawers. There are 24 flask ports in the upper four drawers, 6 in each floor. Each port allows the automated valve opening and closing of one inserted flask. The lowest drawer contains the control electronics and all necessary components for the sampling procedure (e.g. pumps, valves, pressure sensors). It is necessary to connect barcode scanner, monitor, mouse and keyboard to operate the device.

There is also a 12 flask port version (see Figure 9) available. An additional ICOS Air-Dryer (see Figure 10) allows to pre-dry the air before sampling.



Figure 9: 24 port ICOS Flask-Sampler



Figure 10: 12 port ICOS Flask-Sampler



Figure 11: ICOS Air-Dryer

6.2. Location

The device must be operated at a fixed location within a building. To avoid the risk of tipping, when several drawers are opened at the same time, it is recommended to attach the unit to the wall with suitable means. If the flask sampler is not fixed, lock all four rollers.



Figure 12: locked roller

6.3. Connections

! The inlet pressure shall not exceed 2.0 bar(a).

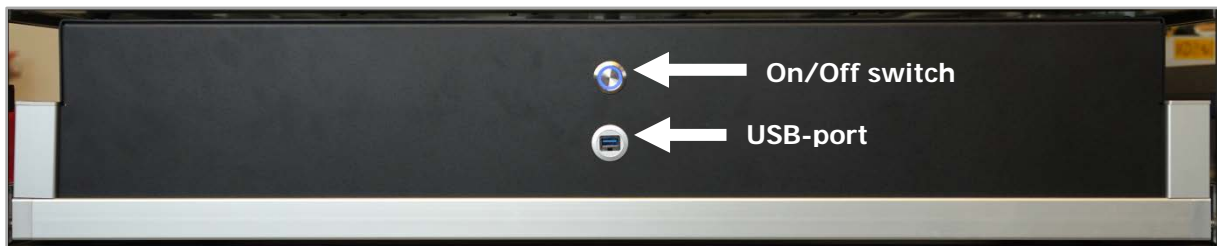

Figure 13: Front view - control drawer



Figure 14: Back view - control drawer

6.3.1. CAN Interface

The CAN-Interface allows connecting external devices to the CAN-bus system (e.g. an air drying unit).

Sub-D 9-pin female	Description
1	GND
2	GND
3	CAN High
4	NC
5	CAN Low
6	NC
7	NC
8	NC
9	NC

! When no ICOS Air-Dryer is used, connect a 120 Ω terminating resistor to the CAN interface!

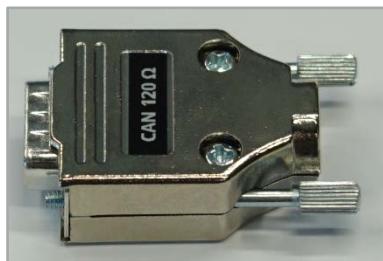

Figure 15: CAN terminating resistor (120 Ω)

6.3.2. COM Interface

The COM-Interface is directly connected to the COM1 port on the computer mainboard.

Sub-D 9-pin male	Description
1	CD - carrier detect
2	RXD - receive data
3	TXD - transmit data
4	DTR - data terminal ready
5	GND - system ground
6	DSR - data set ready
7	RTS - request to send
8	CTS - clear to send
9	RI - ring indicator

6.3.3. GPIO-Interface (General Purpose Input/Output)

On the back of the control drawer a 37-pin sub-D socket is installed. It provides the following inputs and outputs:

- 2 analog inputs (AI1 – AI2)
- 13 digital IOs (DIO1 – DIO13)
- 2 switchable lines with 24V (for switching external valve/pump)

The digital and analog inputs can be used to trigger the flask sampling by an external event (⇒ 8.10). The switchable 24V lines (R1 and R2) are reserved for switching external devices (e.g. valves, pumps).

The Sub-D 37-pol socket is wired as followed:

sub-D 37 pin female	pin name	software name
19	AI01 (+)	analog input 2
37	AI01 (-)	
18	AI02 (+)	analog input 1
36	AI02 (-)	
17	DIO1 (+)	digital input 1
35	DIO1 (-)	
16	DIO2 (+)	digital input 2
34	DIO2 (-)	
15	DIO3 (+)	digital input 3
33	DIO3 (-)	
14	DIO4 (+)	digital output 1*
32	DIO4 (-)	
13	DIO5 (+)	digital output 2 (enable logger)
31	DIO5 (-)	
12	DIO6 (+)	digital input 4 (logger trigger)
30	DIO6 (-)	
11	DIO7 (+)	digital input 5 (activate bar code)
29	DIO7 (-)	

sub-D 37 pin female	pin name	software name
10	DIO8 (+)	digital input 6 (emergency stop)
28	DIO8 (-)	
9	DIO9 (+)	digital input 7 (start sampling)
27	DIO9 (-)	
8	DIO10 (+)	digital input 8 (logger flag 1)
26	DIO10 (-)	
7	DIO11 (+)	digital input 9 (logger flag 2)
25	DIO11 (-)	
6	DIO12 (+)	digital input 10 (logger flag 4)
24	DIO12 (-)	
5	DIO13 (+)	digital input 11 (logger flag 8)
23	DIO13 (-)	
1+2	R1 24V (+)	relay 24V 1 (max 0,5 A!)
22+21+20	R1 24V (-)	
3+4	R2 24V (+)	relay 24V 2 (max 0,5 A!)
22+21+20	R2 24V (-)	

*these pins are currently not supported by the software

pin type	description
analog inputs:	detect analog signals between 0 V and 5 V
digital input/outputs:	detect/write 0 V (low) or 5 V (high)
relay 24V:	switches on/off 24 V for an external pump / magnet valve to purge the inlet line if the sampler is not taking samples (must be activated by setting jumper)
digital output 2 (enable logger):	high level enables sampling condition check by data logger (data logger required)
digital input 4 (logger trigger):	high level starts flask sampling by data logger (data logger required)
digital input 5 (activate barcode scan):	high level activates barcode scanner (chapter 0)
digital input 6 (emergency stop):	high level triggers software emergency shut down
digital input 7 (start sampling):	high level starts flask sampling manually (same functionality as "START SAMPLING" button, chapter 8.2)
digital input 8-11 (logger flags):	start condition identifier (0-15) for data logger triggering (data logger required)

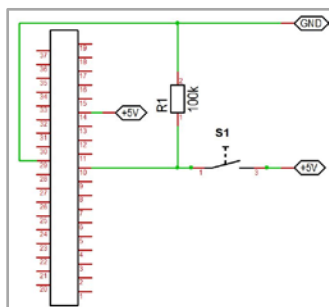

! Use a 100k Ohm resistor between GND and the digital input pin! You can use 5 V from pin 14.

Figure 16: example of wiring an emergency stop button

7. Insert and remove flasks

7.1. Prepare flask ports

When the flask sampler is delivered, every flask port is protected with a blind plug. Before a flask can be inserted, the blind plug must be replaced by a sleeve.

! Make sure that an O-ring is sitting between sleeve or blind plug and the fitting body. (for replacement - see ordering information on chapter 12)

! When no flask is mounted the blind plugs have to be inserted.



Figure 17: components of a flask port

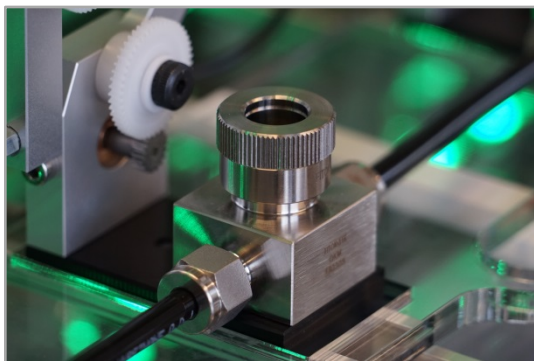

Figure 18: port with sleeve

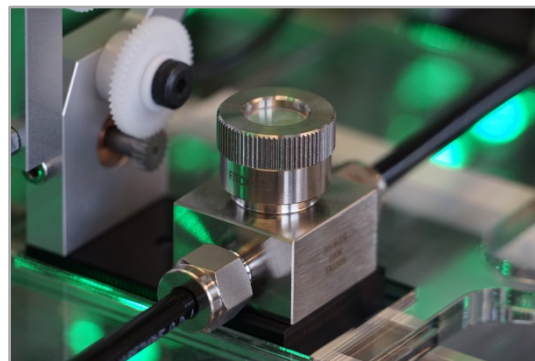

Figure 19: port with blind plug

7.2. Insert flask (physically)



Danger of glass breakage in connection with overpressure (protective equipment: eye protective goggles)!

- Open the drawer,
(1) Move rear flask ports to the appropriate flask size
1. (2) open the clips

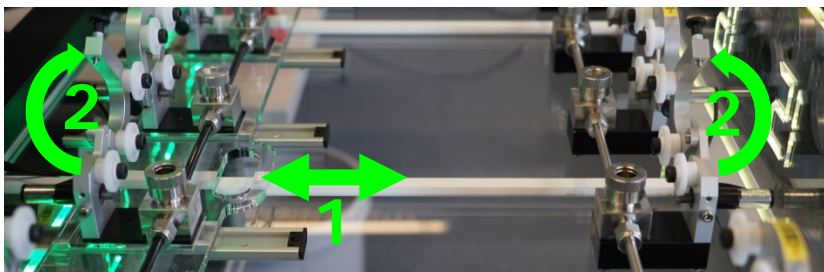

2. Take the flask with two hands (between forefinger and thumb)



3. Put the flask carefully into the port (**don't hit the glass tube on the fitting**)



4. Close the clips until it locks in place (**be careful, don't close with force**)



5. Tighten the fitting nut firmly (clockwise)

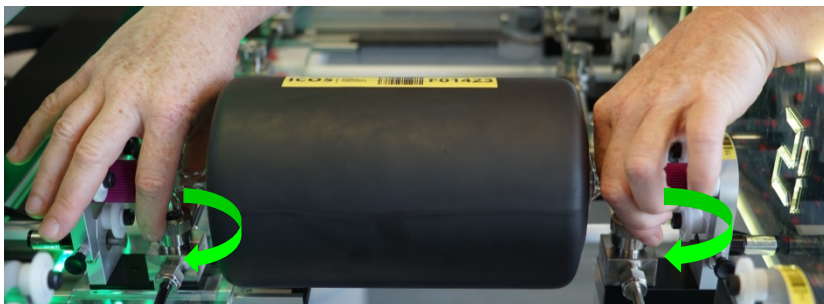

When no flask is mounted, the blind plugs have to be inserted.

7.3. Insert and remove flask procedure

! Before inserting a flask for the first time, be sure to use the latest flask list (⇒ 8.8)!

! Activate the barcode scanner (left mouse click on the green button in the “sampler overview” tab, chapter 8.1)!

Insert flask procedure:

1. Open a drawer (move the drawer completely out)
2. Insert one or more flasks as described in chapter 7.2
3. Enable mount flask mode with the barcode scanner (scan “mount flask” - barcode on the side of the drawer, see Figure 19, drawer front color will turn cyan)
4. Assign each inserted flask to a port (first scan the port-barcode and secondly scan the USN-barcode on the flask, see Figure 20 and Figure 21)
5. Close the drawer (until it locks in place)

Remove flask procedure:

6. Open the drawer (move the drawer completely out)
7. Enable unmount flask mode (scan “unmount flask” - barcode on the side of the drawer, see Figure 19, drawer front color will turn purple)
8. Scan port or flask barcode of the flasks to be removed (see Figure 20 and Figure 21)
9. Remove flasks (⇒ 7.2)
10. Insert new flasks (see above)
11. Close the drawer (until it locks in place)

! After closing the drawer the system will perform an automatic leak test to make sure that the flasks are properly inserted.

! You get an optical feedback by the LED light after assign a flask to a port
Green – action successful
Red – action not successful (read info box on the screen)

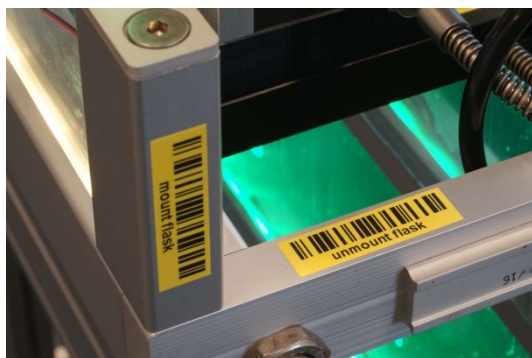

Figure 20: mount and unmount barcode



Figure 21: port barcode



Figure 22: UCN (Unique Container Number) number as barcode on the flask

7.4. Sampler ready for sampling self-test

Each time after you opened and closed a sampler drawer and before sampling procedures, it is ensured that:

- All flasks are closed
- All ports are closed with either flasks or blind plugs
- All nuts are tighten

Three seconds after the last open drawer was closed the sampler starts to gently try to turn all mounted flask heads, to check for open valves. If flask valves are open the sampler tries to close the valves and marks them as possibly water contaminated. After that the internal sampler pump starts and all ports are pumped. After reaching a pressure threshold (this can take up to 2 minutes) the sampler is considered as ready for sampling. The sampler tubing will be pressurized to 1.6 bar(a) and the front color will turn to green.

In case of loose nuts, the pumping time will be longer as usual and the pressure will not decrease.

- Open the drawer with the last inserted flasks and check the nuts
- If the pressure threshold is reached while the drawer is still open the front color will switch to green for two seconds
- The sampler test will stop after:
 - you closed all drawers and the pumping threshold was reached
 - you pressed the procedure's stop button ((3) in chapter 8.3.)
 - or a timeout occurred
- After successful sampler test the state of the newly inserted flasks change from "inserted" to "mounted". The flasks are now available for sampling events.

! If you open a drawer while the sampler is at over pressure the sampler will immediately open its valves and release over pressure.

! If you open a drawer while the sampler is at over pressure and a procedure is running then you have three seconds to close the drawer again before the sampling is aborted and the flask valves are closed.

! If you open a drawer while a procedure is running at under pressure the procedure will continue but it will stop as soon as an over pressure state is reached.

8. Software

8.1. Overview

After switching on the flask sampler, you will see the following screen:

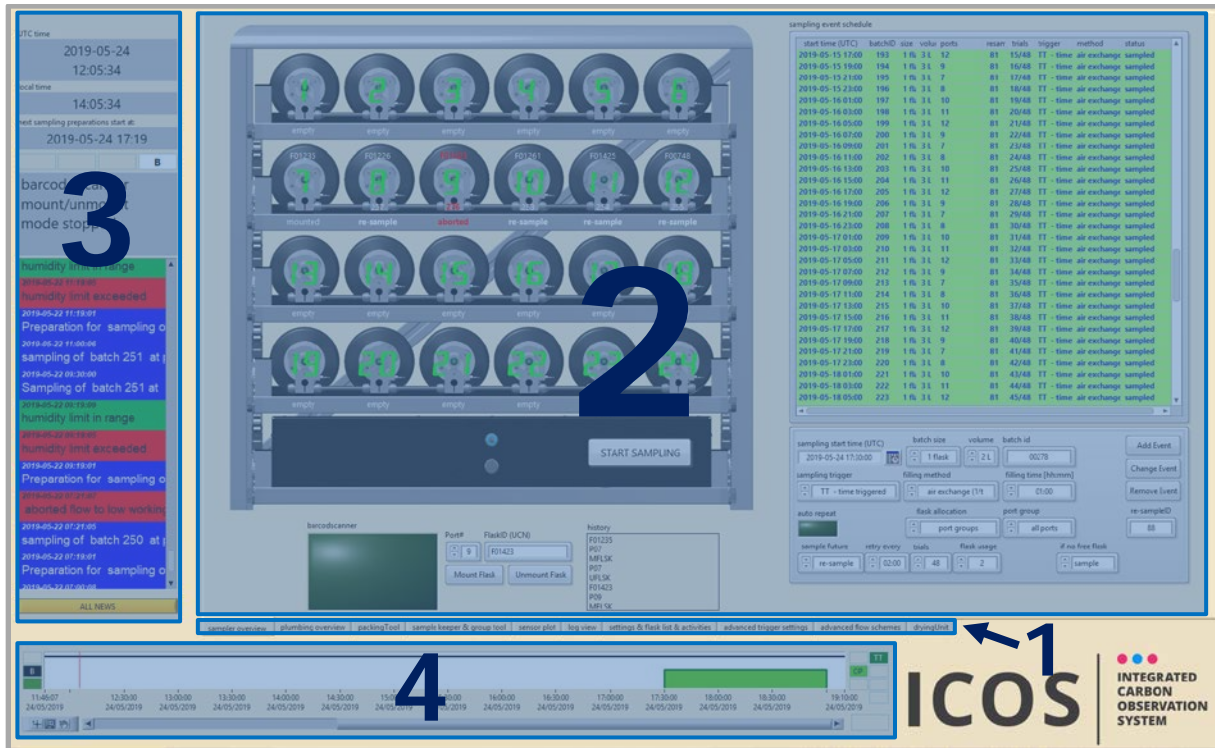

1 – Selectable tabs

The following tabs can be selected:

- sampler overview ⇒8.2
- plumbing overview ⇒8.3
- packing tool ⇒8.4
- sample keeper & group tool ⇒8.5
- sensor plot ⇒8.6
- log view ⇒8.7
- settings & flask list & activities ⇒8.8
- drying unit (only if a dryer is connected and activated) ⇒8.9
- advanced trigger settings (only if expert mode is activated) ⇒8.10
- advanced flow schemes (only if expert mode is activated) ⇒8.11

2 – Main view

Displays the selected tab

3 – Event viewer

Shows the following contents:

- UTC time
- Local time
- Next sampling date
- Flags for water, humidity, flow to low and emergency off (only if active) and states of the Air Dryer traps
- Event messages

4 – Time line plot ⇒8.12

Shows scheduled events in a time line

8.2. Sampler Overview

This tab shows all inserted flasks and their state (1). Each sampling event is identified by a unique integer (batchID). Sampling events have to be assigned (⇒ 8.2.2). Manually triggered sampling events can be started using the “START SAMPLING” button (4). On the right is the sampling event schedule located (2). Below you find buttons for the flask mount/unmount procedure (4).

The screenshot displays the ICOS Flask-Sampler interface. On the left, a grid of 24 flask ports is shown, numbered 1 to 24. Each port has a status indicator: 'empty', 'mounted', 're-sample', or 'absent'. A large blue number '1' is overlaid on the grid. Below the grid is a 'START SAMPLING' button with a blue number '3' overlaid. At the bottom left, there is a 'barcodescanner' section with a 'Port#' dropdown (set to '9') and an 'Unmount Flask' button, with a blue number '4' overlaid. On the right, a 'sampling event schedule' table lists events with columns for start time, batchID, size, volume, ports, resan, trials, trigger, method, and status. A large blue number '2' is overlaid on the table. Below the table are control fields for 'sampling start time (UTC)', 'batch size', 'volume', 'batch id', 'sampling trigger', 'filling method', 'filling time [h:mm]', 'auto repeat', 'flask allocation', 'port group', 're-sampleID', 'sample future', 'retry every', 'trials', 'flask usage', and 'if no free flask'.

start time (UTC)	batchID	size	volume	ports	resan	trials	trigger	method	status
2019-05-15 17:00	183	1 fl	3 L	12	81	15/48	TT	time air exchange	sampled
2019-05-15 18:00	184	1 fl	3 L	9	81	16/48	TT	time air exchange	sampled
2019-05-15 21:00	195	1 fl	3 L	7	81	17/48	TT	time air exchange	sampled
2019-05-15 23:00	196	1 fl	3 L	8	81	18/48	TT	time air exchange	sampled
2019-05-16 01:00	197	1 fl	3 L	10	81	19/48	TT	time air exchange	sampled
2019-05-16 03:00	198	1 fl	3 L	11	81	20/48	TT	time air exchange	sampled
2019-05-16 05:00	199	1 fl	3 L	12	81	21/48	TT	time air exchange	sampled
2019-05-16 07:00	200	1 fl	3 L	9	81	22/48	TT	time air exchange	sampled
2019-05-16 09:00	201	1 fl	3 L	7	81	23/48	TT	time air exchange	sampled
2019-05-16 11:00	202	1 fl	3 L	8	81	24/48	TT	time air exchange	sampled
2019-05-16 13:00	203	1 fl	3 L	10	81	25/48	TT	time air exchange	sampled
2019-05-16 15:00	204	1 fl	3 L	11	81	26/48	TT	time air exchange	sampled
2019-05-16 17:00	205	1 fl	3 L	12	81	27/48	TT	time air exchange	sampled
2019-05-16 19:00	206	1 fl	3 L	9	81	28/48	TT	time air exchange	sampled
2019-05-16 21:00	207	1 fl	3 L	10	81	29/48	TT	time air exchange	sampled
2019-05-16 23:00	208	1 fl	3 L	11	81	30/48	TT	time air exchange	sampled
2019-05-17 01:00	209	1 fl	3 L	12	81	31/48	TT	time air exchange	sampled
2019-05-17 03:00	210	1 fl	3 L	9	81	32/48	TT	time air exchange	sampled
2019-05-17 05:00	211	1 fl	3 L	10	81	33/48	TT	time air exchange	sampled
2019-05-17 07:00	212	1 fl	3 L	11	81	34/48	TT	time air exchange	sampled
2019-05-17 09:00	213	1 fl	3 L	12	81	35/48	TT	time air exchange	sampled
2019-05-17 11:00	214	1 fl	3 L	9	81	36/48	TT	time air exchange	sampled
2019-05-17 13:00	215	1 fl	3 L	10	81	37/48	TT	time air exchange	sampled
2019-05-17 15:00	216	1 fl	3 L	11	81	38/48	TT	time air exchange	sampled
2019-05-17 17:00	217	1 fl	3 L	12	81	39/48	TT	time air exchange	sampled
2019-05-17 19:00	218	1 fl	3 L	9	81	40/48	TT	time air exchange	sampled
2019-05-17 21:00	219	1 fl	3 L	10	81	41/48	TT	time air exchange	sampled
2019-05-17 23:00	220	1 fl	3 L	11	81	42/48	TT	time air exchange	sampled
2019-05-18 01:00	221	1 fl	3 L	12	81	43/48	TT	time air exchange	sampled
2019-05-18 03:00	222	1 fl	3 L	9	81	44/48	TT	time air exchange	sampled
2019-05-18 05:00	223	1 fl	3 L	10	81	45/48	TT	time air exchange	sampled

8.2.1. Flask ports

Whenever a flask is mounted, you will see the flask number (UCN) at the port. If a flask is assigned to an event, you will see a batch number at the port:

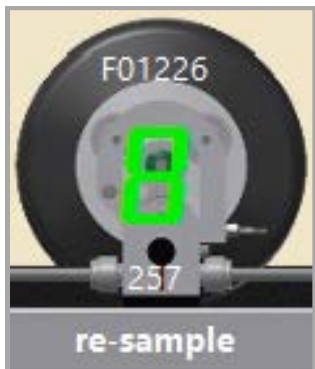

UCN (Unique Container Number)

Flask port number

Scheduled batch number

Flask port state

Move the mouse over the flask port to view detailed information about the inserted flask.

The following flask states are shown at each of the 24 ports:

Flask port state	Description
empty	port is empty (or the inserted flask is not mounted)
inserted	flask is inserted, the mount process is not finished (leak test)
mounted	flask is mounted, all nuts are closed, flask available for sampling
waiting	flask is scheduled for an event and is not otherwise available
preparing	sampling procedure is in preparation (leak test, purging, open flasks etc.)
sampling	sampling is currently running
sampled	flask is sampled and can be removed
keep?	this flask has already been sampled, it still has to be decided if this flask will be kept
re-sample	this flask has already been sampled and is ready for a next sampling
humid?	flask is contaminated because of water flag while flask was open
aborted	sampling was aborted (by pressing stop button or due to an error)

8.2.2. Create sampling events

Create sampling events:

1. choose a sampling start time (not necessary in manually or advanced trigger mode)
2. select flask volume (1, 2 or 3 liter)
3. select trigger mode (time triggered, manually or an advanced trigger protocol)
4. select filling method (⇒ chapter 9)
5. select filling time or exchange factor (depends on selected filling method)
6. select a flask allocation (select a direct port or use port groups)
7. select what should happen with the sample in future (keep, re-sampler or ask ATC)
8. press "Add event button"

The screenshot shows a 'sampling event schedule' window with a table of events and a configuration panel below it.

start time (UTC)	batchID	size	volu	ports	resam	trials	trigger	method	status
2019-05-23 03:30	260	1 fl.	2 L	7	86	30/48	TT - time	air exchange	sampled
2019-05-23 05:30	261	1 fl.	2 L	7	86	31/48	TT - time	air exchange	sampled
2019-05-23 07:30	262	1 fl.	2 L	7	86	32/48	TT - time	air exchange	sampled
2019-05-23 09:30	263	1 fl.	2 L	7	86	33/48	TT - time	air exchange	sampled
2019-05-23 11:30	264	1 fl.	2 L	7	86	34/48	TT - time	air exchange	sampled
2019-05-23 13:30	265	1 fl.	2 L	7	86	35/48	TT - time	air exchange	sampled
2019-05-23 15:30	266	1 fl.	2 L	7	86	36/48	TT - time	air exchange	sampled
2019-05-23 17:30	267	1 fl.	2 L	7	86	37/48	TT - time	air exchange	sampled
2019-05-23 19:30	268	1 fl.	2 L	7	86	38/48	TT - time	air exchange	sampled
2019-05-23 21:30	269	1 fl.	2 L	7	86	39/48	TT - time	air exchange	sampled
2019-05-23 23:30	270	1 fl.	2 L	7	86	40/48	TT - time	air exchange	sampled
2019-05-24 01:30	271	1 fl.	2 L	7	86	41/48	TT - time	air exchange	sampled
2019-05-24 03:30	272	1 fl.	2 L	7	86	42/48	TT - time	air exchange	sampled
2019-05-24 05:30	273	1 fl.	2 L	7	86	43/48	TT - time	air exchange	sampled
2019-05-24 07:30	274	1 fl.	2 L	7	86	44/48	TT - time	air exchange	stopped by u
2019-05-24 07:30	277	1 fl.	2 L	7	87	2/48	TT - time	air exchange	stopped by u
2019-05-24 08:09	276	1 fl.	2 L	9	87	1/48	TT - time	air exchange	stopped by u
2019-05-24 17:30	278	1 fl.	2 L	all ports(6)	88	1/48	TT - time	air exchange	waiting

The configuration panel below the table includes:

- sampling start time (UTC): 2019-05-24 01:30:00
- batch size: 1 flask
- volume: 2 L
- sampling trigger: TT - time triggered
- filling method: air exchange (1/t)
- filling time [hh:mm]: 01:00
- auto repeat: (disabled)
- flask allocation: port groups
- port group: all ports
- sample future: keep sample

The events color displayed in the list indicate the following states:

Schedule state	Description
bold blue letters	event scheduled and flasks assigned
normal black letters / white background	waiting - event scheduled but not enough free flasks yet
green background	sampled
yellow background	waiting for trigger
orange background	sampling is currently running
red background	sampling problem

! Use the auto repeat option for periodic events (e.g. re run every day)

The screenshot shows the configuration panel with the 'auto repeat' checkbox checked and the 'auto repeat every' field set to '1d 00:00'. Other settings are the same as in the previous screenshot.

8.2.3. Flask mount/unmount buttons

Inserted flasks must be assigned to the right flask port (⇒ 7.3). You can mount and unmount flasks by using the barcode scanner or manually with keyboard and mouse. Activate the barcode scanner by pressing the switch (light green is enabled).

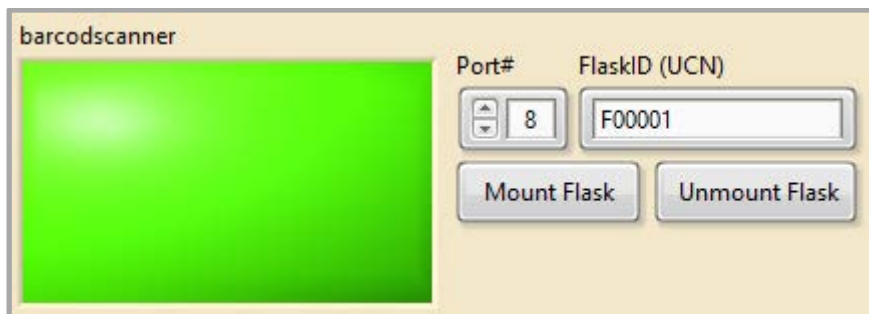

! Before inserting a flask for the first time into the sampler, you need to register it. Send your flask for conditioning and registration to the ICOS-CAL FCL in Jena (⇒ chapter 13).

8.3. Plumbing Overview

A Flow scheme of the complete device is shown on this screen (2). A leak test tool (1) is used for starting leak tests of selected flasks or the whole system. When procedures (sampling, leak tests) are running, status and further details are shown (3).

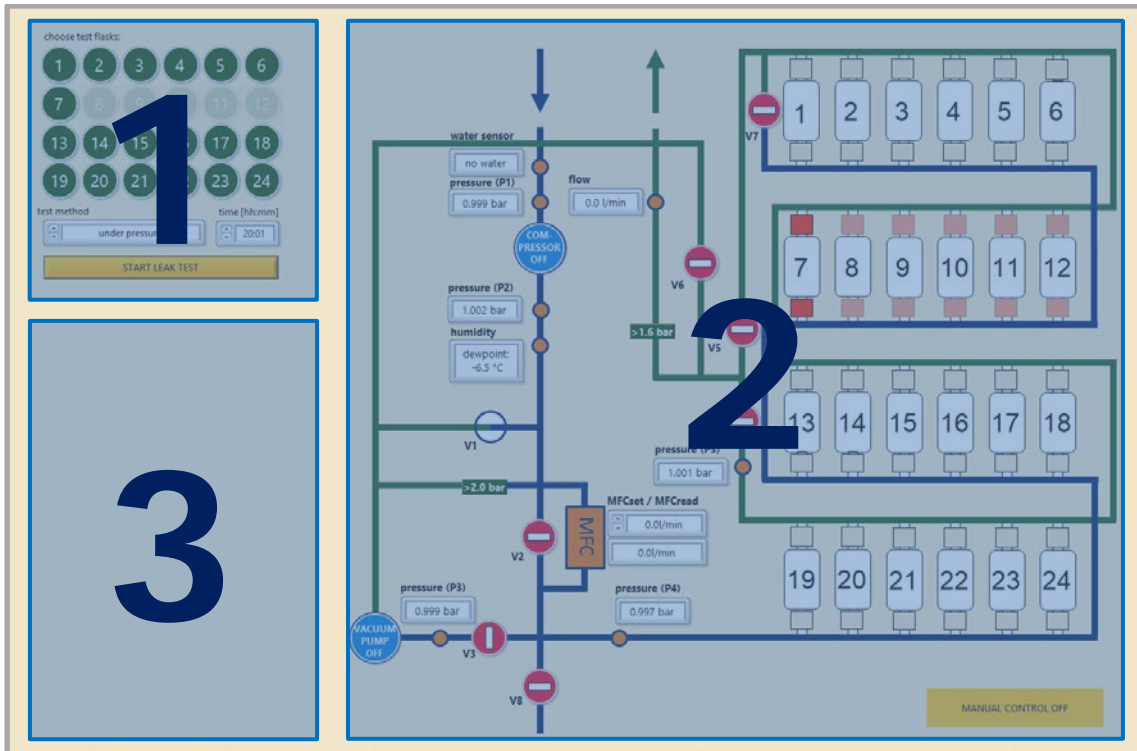

8.3.1. Leak test tool

The built in pressure sensors allow to determine the volume of the system. Pressure differences can be measured over time and a leak rate can be calculated.

Flask leak test:

1. select one or more flasks by left clicking
2. select leak test method (over or under pressure)
3. select the leak test duration
4. start leak test
5. get a leak rate

System leak test:

1. select no flasks
2. select leak test method (over or under pressure)
3. select the leak test duration
4. start leak test
5. get a leak rate

! The leak rate estimation method overestimates the leak rate at short times and will decrease with time. You can follow the leak rate drop over time at the sensor plot tab (chapter 8.6).

8.3.2. Flow scheme

The flow scheme shows the states of all integrated valves, pumps, flask ports, sensors and the mass flow controller. Dark blue tubes are made from stainless steel. No entry signs stand for closed valves and overpressure valves that open at pressures >1.6 bar(a) and 2.0 bar(a) are green boxes. Sensor names appear with moving your mouse over a sensor.

Only for test purposes: Push the "Manual Control Off" button to enable access to the flow scheme. Now it's possible to switch each valve, start the pump, etc.

Valve head color code	Description
green	flask valve open
red	flask valve closed
yellow	flask valve opening or closing
greyed	flask contains sample

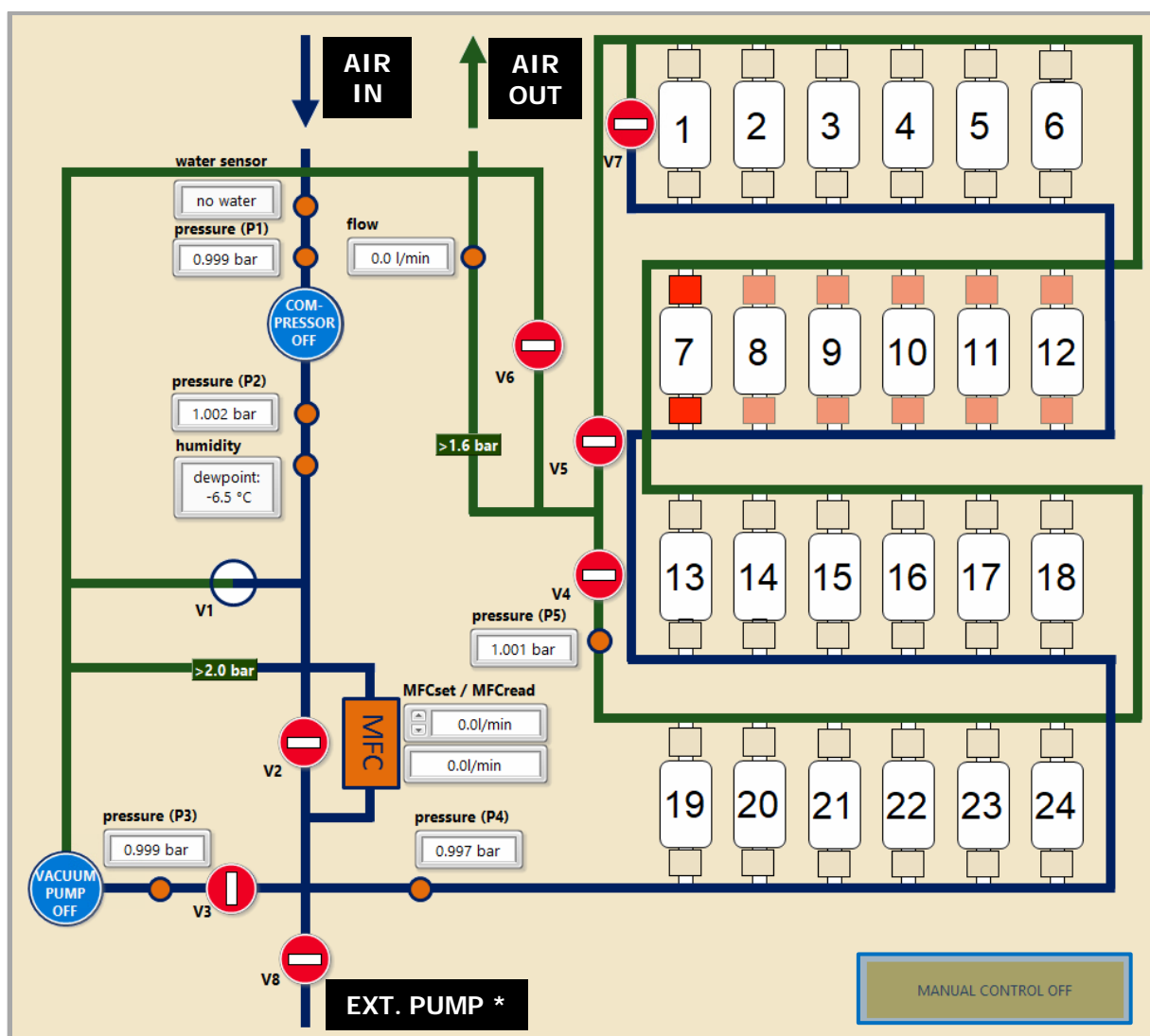

*an ext. pump is not necessary for standard samplings / the ext. pump output V8 is no longer available in newer hardware versions

8.4. Packing tool

Use this tool for packing flasks into a transport container and submit the flask information to ICOS CAL in the following way:

1. activate the barcode scanner by pressing the switch (1) - light green is enabled
2. scan the transport container barcode label - see Figure 23
3. open drawer and add all flasks belonging to a transport container by scanning the flask barcode label (UCN) - see Figure 22
4. make sure that the "#flasksInBox" counter matches the number of flasks you plan to place in the box
5. scan barcode or press button: "SEND/SAVE DATA" to complete the process (2)
 - a. offline mode: browse to C:_logfiles\packedBoxes and send the zip file to icos-flasks@bgc-jena.mpg.de
 - b. online mode: activate "send data to CAL using FTP" and scan "send/saveData"
6. remove the flasks and put them physically into the transport container (removing flask ⇒ 7.2)
7. Scan "goToMountFlask" (3) to insert and mount the next flasks (⇒ 7.3)

sampleData

sampleID	flaskID	conditioningRequired	batchID	batchSize	startTime	endTime	flaskVolume	flask
1	F00668	0	1	1	2019-04-18 15:36:21	2019-04-18 16:46:22	2	15
97	F01635	0	113	1	2019-05-03 07:47:56	2019-05-03 07:55:56	3	16
185	F01633	0	222	1	2019-05-18 03:00:00	2019-05-18 04:30:00	3	11
187	F01631	0	224	1	2019-05-18 07:00:00	2019-05-18 08:30:02	3	9

mounted flasks

1	2	3	4	5	6
7	8	9	10	11	12
13	14	15	16	17	18
19	20	21	22	23	24

data available at:
C:_logfiles\packedBoxes

send your boxes to:
**Max-Planck-Institute for Biogeochemistry
CAL - Flask and Calibration Laboratory
Kahlaische Str. 4 / Eingang C
D-07745 Jena
Germany**

email contact:
icos-flasks@bgc-jena.mpg.de



Figure 23: flask with barcode (UCN)



Figure 24: transport box with box number

8.5. Sample keeper & group tool

(1) sample keeper

The sample keeper allows marking already sampled flask as "keep" or "re-use"

1. select one or more flask which you want to edit
2. select one of the following options:
 - a. "keep" - the flask will be kept and marked as "sampled" - the flask will not be sampled again.
 - b. "re-use" - the flask will be marked as "re-sample" - the flask will be sampled again at a next sampling event
 - c. "ask ATC" - the ATC decide if the sample will be kept and mark the flask as "sampled" or "re-sample" – in addition a test method (QC – quality control or ffCO₂ – fossil fuel CO₂) must be selected

(2) group tool

The group tool allows combining different ports as a group. New groups can be created or existing groups can be used for creating new sampling events (⇒ 8.2.2.)

(3) ATC connection data

The access data of the ATC should be entered in this box.

The screenshot displays three distinct sections of the software interface, each marked with a large blue number:

- 1:** A table titled "sampleEvents" with columns: port, flaskID, startTime, endTime, sampleID, batchID, resamp, trials, volu, trigger, method, usa, status. The table contains several rows of data, with row 9 highlighted in blue.
- 2:** A "groups" tool interface showing a grid of ports (Port 1 to Port 22) and a "groups" list on the right. A group named "group1" is selected, and a "create new" button is visible.
- 3:** The "HIDE ATC CONNECTION DATA" form. It includes fields for "ATC login", "ATC password", "connect at" (09:30), "re-try every" (02 h), "ATC instr. ID" (0), and a checkbox for "always reconnect". A "TEST CONNECTION" button is present. A text box below the form says "insert correct ATC connection data and press 'test connection'".

8.6. Sensor plot

This tab shows all logged sensor data (pressure, flow, temperature, dew point) over time. Move the cursor (1) to display the data values (2) at the current cursor position. Select a start time (3) and a time window to show data from preceding times. If an Air-Dryer is connected, the dew point and temperature data will be shown in the bottom diagram.

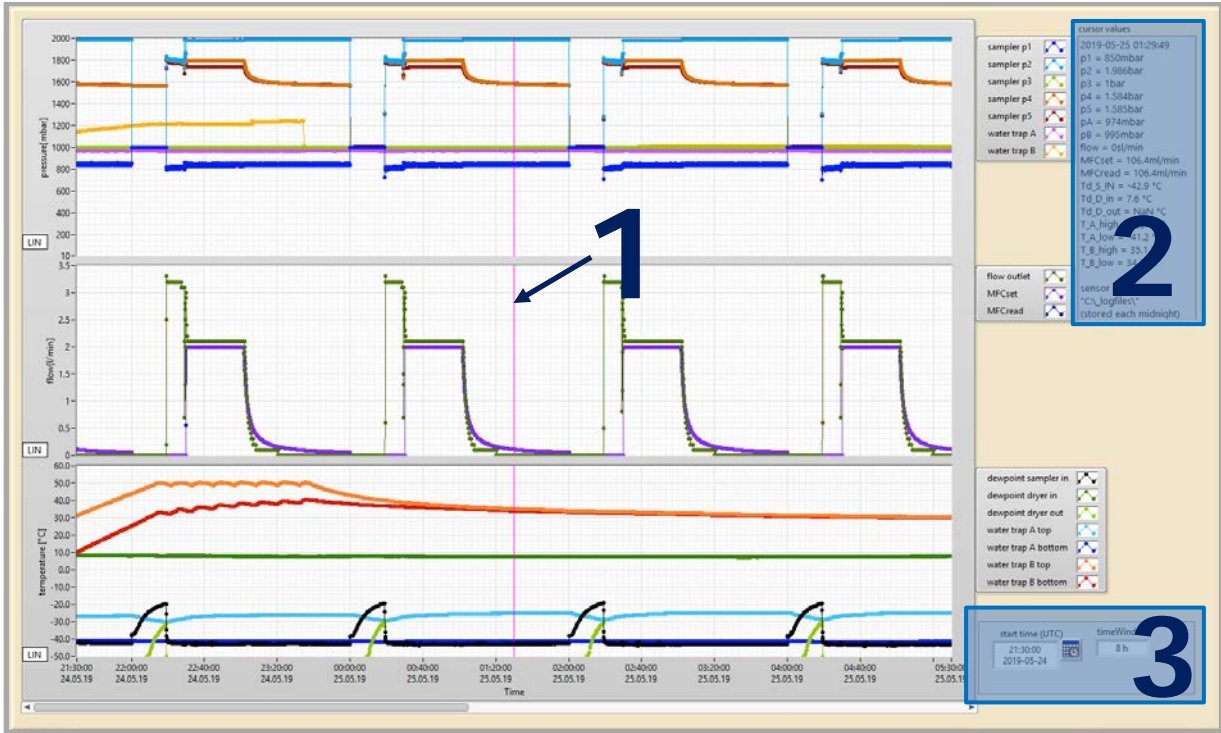

! All logged data are stored as csv files ("C:_logfiles")

8.7. Log View

The log view tab shows all data (1, temperature, humidity, valve states, pressure, and flow) of a single sampling event selected from the sampling event list (3). The history log (2) shows all events between mounting and unmounting of the designated flask.

Select an event in the list below and set the filters at the right side as required.



! All logged data are stored as csv files ("C:_logfiles")

8.8. Settings & flask list & activities

This tab contains:

- log list of recent activities (1)
- station data (2) ⇒ 8.8.1
- Flask-Sampler and Air-Dryer settings (3) ⇒ 8.8.2
- flask list of all registered flasks (4) ⇒ 8.8.3.

The screenshot displays four distinct panels from the ICOS software interface:

- Panel 1 (Activities):** A table listing recent activities with columns for date/time, port, flaskID, batchID, and message. The messages include events like 'air trap A waits for dry', 'sampling started', and 'front valve already open'.
- Panel 2 (Station Data):** A form for entering station information, including site name, code, operator, and geographic coordinates (latitude, longitude, altitude, intake height).
- Panel 3 (Settings):** A configuration area for operational modes such as 'continuous serial check', 'campaign mode', and 'use external pump', along with various timing and temperature parameters.
- Panel 4 (Flask List):** A table listing all registered flasks, showing flaskID (UCRN), volume, and owner information.

8.8.1. Station data

! Before first use, fill in the sampling parameter (site name, site code, operator, etc.)!
Don't forget to press save changes button! Check <https://meta.icos-cp.eu/labeling/> for station properties.

site name			
Das ist ein TestSiteName			
site code	samplerID	sampler operator	
FCL		Misses A	
station/campaign principal investigator(s)			
Mister B, Mister C			
latitude	longitude	altitude	intake height
1.523421	-1.875423	100 m	7 m

8.8.2. Flask-Sampler and Air-Dryer settings

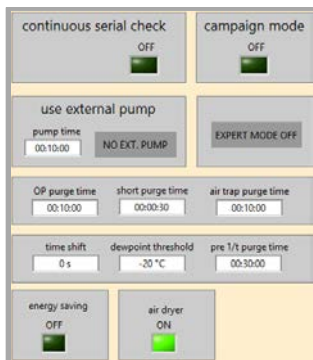

continuous serial check: if active, the serial port is continuous scanning for commands

campaign mode: activate the campaign mode to change the site parameters during a campaign

use external pump: use this setting if an external under pressure pump is connected to the flask sampler. Adjust the pump time before time integrated sampling (filling method “flaks fill with const. flow”)

expert mode: extends the tab bar with the tabs “advanced trigger settings” and “advanced flow schemes”

OP purge time: purge time before over pressure sampling starts (can be used to adjust the purge time for the intake line)

short purge time: purge time between consecutive samplings

air trap purge time: air trap purge time before a sampling starts

time shift: adds a time shift before the sampling starts

Dew point threshold: this threshold value must be reached before purging starts

pre 1/t purge time: flask purge time before the 1/t sampling starts

energy saving: activate the energy saving mode (all lights are switched off after a few minutes)

air dryer: activate the connected Air-Dryer for remote controlled samplings

8.8.3. Flask list

Before inserting a flask for the first time into the sampler, you need to register it. Send your flask for conditioning and registration to the ICOS-CAL FCL in Jena (chapter 13).

flaskID (UCN)	volume	owner
F00001	2L	CAL - FCL
F00002	2L	CAL - FCL
F00003	2L	CAL - FCL
F00004	2L	CAL - FCL
F00005	2L	CAL - FCL
F00006	2L	CAL - FCL
F00007	2L	CAL - FCL
F00008	2L	CAL - FCL
F00009	2L	CAL - FCL
F00010	2L	CAL - FCL
F00011	2L	CAL - FCL
F00012	2L	CAL - FCL
F00013	2L	CAL - FCL
F00014	2L	CAL - FCL
F00015	2L	CAL - FCL
F00016	2L	CAL - FCL
F00017	2L	CAL - FCL
F00018	2L	CAL - FCL
F00019	2L	CAL - FCL
F00020	2L	CAL - FCL
F00021	2L	CAL - FCL
F00022	2L	CAL - FCL
F00023	2L	CAL - FCL
F00024	2L	CAL - FCL
F00025	2L	CAL - FCL
F00026	2L	CAL - FCL
F00027	2L	CAL - FCL
F00028	2L	CAL - FCL
F00029	2L	CAL - FCL
F00030	2L	CAL - FCL
F00031	2L	CAL - FCL
F00032	2L	CAL - FCL
F00033	2L	CAL - FCL
F00034	2L	CAL - FCL
F00035	2L	CAL - FCL
F00036	2L	CAL - FCL
F00037	2L	CAL - FCL
F00038	2L	CAL - FCL
F00039	2L	CAL - FCL

FlaskID (UCN) Volume Add Flask Import File
Owner Change Flask Download
flask inventory version
2019-04-15 13:43:57

The flask list shows all registered flasks within the ICOS network. All registered flasks IDs can be downloaded by pressing the “Download” button. If no internet connection is available, the data can also be imported (“Import file”). It’s only possible to add manually flask which are not labeled as ICOS flasks (e.g. for a special campaign).

8.9. drying Unit

It's sufficient to control the Air Dryer only by the Flask Sampler software. The tab "drying unit" allows you to control all settings and shows the state of both freeze-out-water traps.

! For further information read the ICOS Air-Dryer Manual!

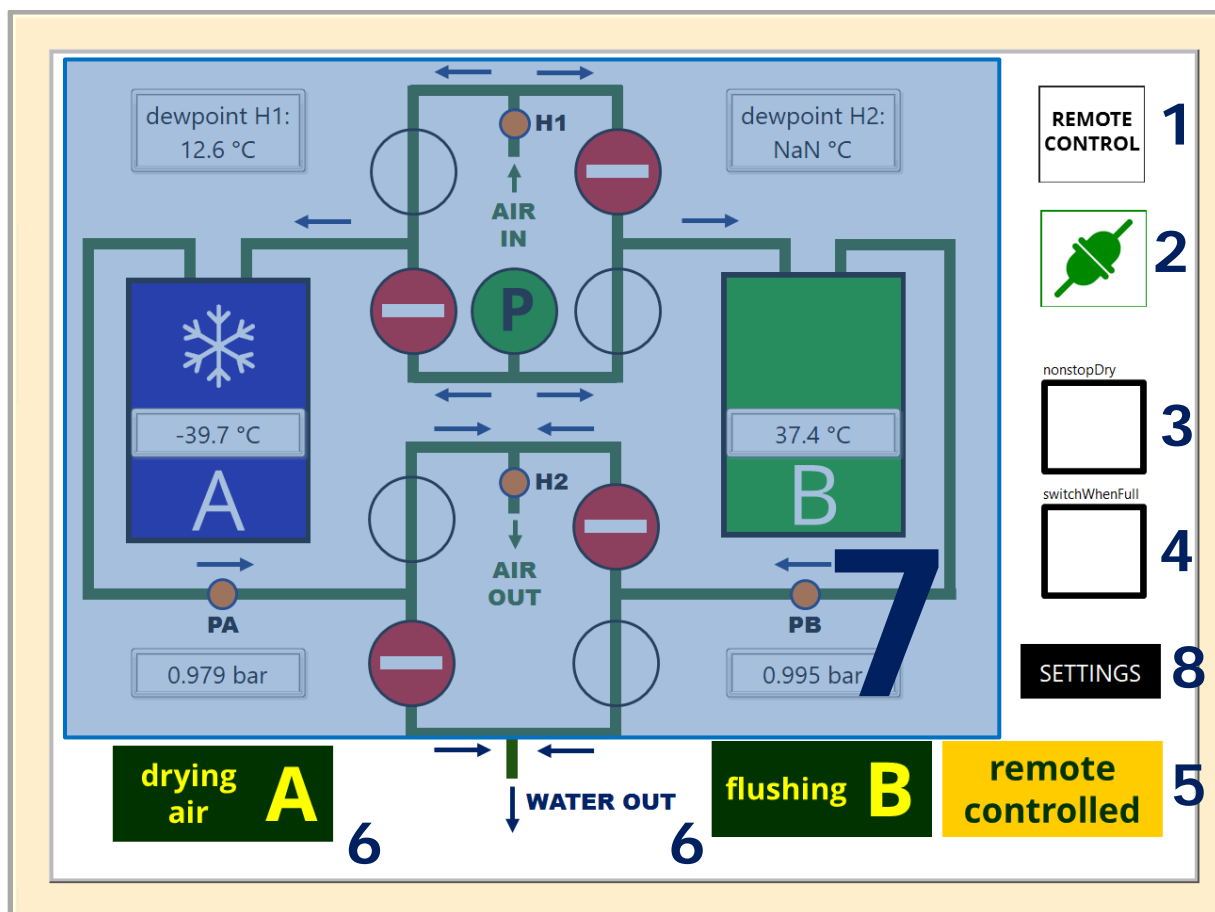

1 – Cycle on/off symbol or remote control

Shows if a drying cycle or remote control by the Flask-Sampler is active

2 – Connection symbol

Indicates if Air Dryer is connected to the Flask-Sampler

3 – nonstop drying button

Press this button to activate a nonstop drying cycle, otherwise the dryer stops after one cycle

➔ not changeable in remote control mode

4 – switch when full button

not active: automatic switching between trap A and B with a preset time interval

active: switching between trap A and B whenever a trap is blocked by ice, no preset switching interval is active

➔ not changeable in remote control mode

5 – start/stop dryer button

Starts or stops the drying process.

➔ not changeable in remote control mode

6 – state trap A/B

Indicates the state of trap A/B and displays errors.



If the drying cycle has been stopped without regeneration, the “trap wet - heat & dry” button is active.

7 – Flow scheme with sensor data and switching states

In this flow scheme are shown all integrated valves, chillers, sensors and the pump.

8 – Settings

Enable the change of default dryer parameters as shown in the diagram. The adjustable under and over pressure threshold prevents to exceed the specified values by opening a valve. These settings should not be changed during routine operation.

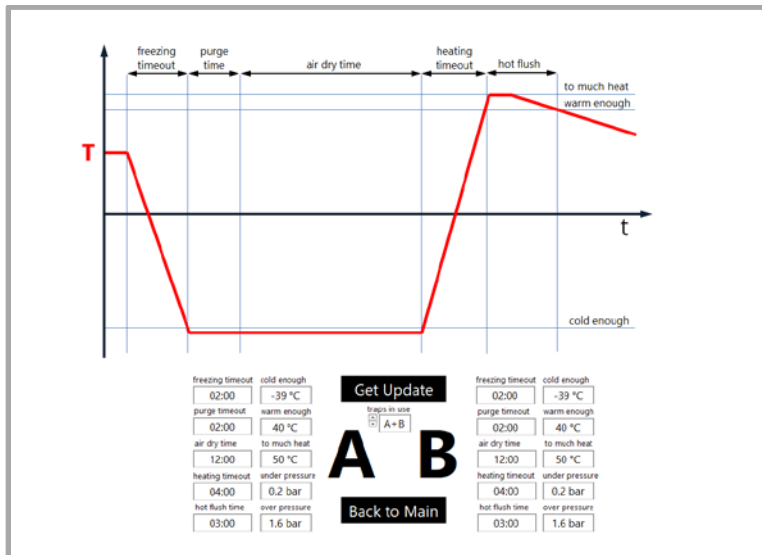

8.10. Advanced trigger settings

The “advanced trigger settings” tab appears only if “expert mode” is enabled (⇒ 8.8.2).

In this tab sets consisting of analog, digital and serial triggers (3) can be created and saved (4). All active trigger channels are AND combined. The analog and digital input pin out is described in chapter 6.3.3. For the serial trigger string the usage of all characters is allowed. The serial input will be scanned until the string is found. The trigger can be tested (2) while detected signals are shown (1). The trigger sets can be assigned to sampling events (⇒ 8.2.2.) with the “sampling trigger” field when “expert mode” is enabled.

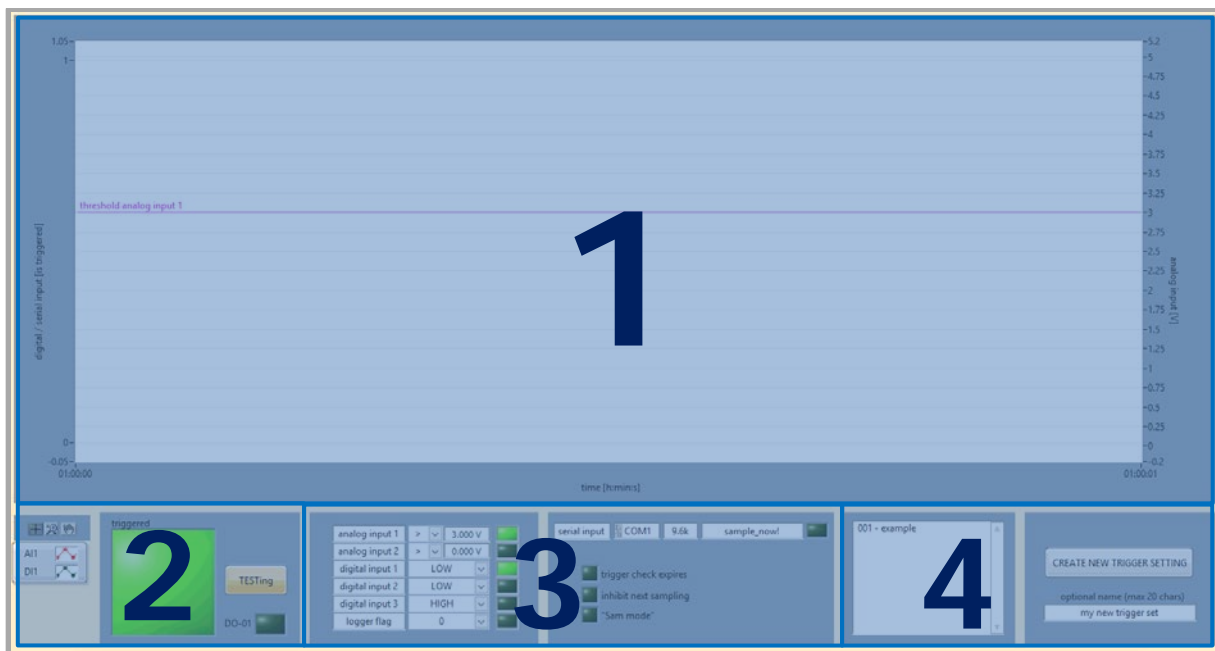

Trigger sets can be associated with the following options:

- Trigger check expires – when no trigger was detected until x minutes after trigger checking started, the trigger check will be stopped and the for the event assigned flasks will be used for other waiting events
- Inhibit next sampling – if an event with this option enabled finishes, then the sampler will not check for further triggered events in the following x minutes
- “Sam mode” – in this mode it is possible to start, stop and restart sampling events with serial commands (⇒ 8.10.1). This modus can be used with overpressure, under-pressure and advanced sampling schemes. Sampling start commands will be refused when the possible sampling time will be less then x minutes before the next scheduled time triggered event starts.

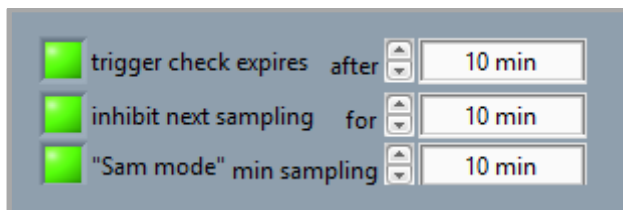

8.10.1. Serial commands

The sampler checks for serial commands:

- when an advanced trigger set with active serial option is running
- when an advanced trigger set with active "Sam mode" option is running
- when the "continuous serial check" option is active (chapter 8.8.2)

! Make sure not to start events with different baud rates at the same time at the same port.

While for serial triggers no restrictions exist, follow control commands a frame scheme:

#yourCommand!\n

The commands are predefined and in upper and lower case version applicable. All commands need to be ended with a line feed character (\n, ASCII#: 0A).

Common commands	Description														
?	please help me (example: <i>#?!)</i>														
GET(option(s))	get current sensor values (multiple options are separated by ";") (example: <i>#get(time;flow;p3;p1)!</i>) options: <table border="0"> <tr> <td>TIME</td> <td>current time in seconds since 1904</td> </tr> <tr> <td>P1;P2;P3;P4;P5</td> <td>pressure sensor values [bar]</td> </tr> <tr> <td>FLOW</td> <td>flow sensor @ outlet [l/min]</td> </tr> <tr> <td>MFC_SET</td> <td>mass flow controller set [l/min]</td> </tr> <tr> <td>MFC_READ</td> <td>mass flow controller readout [l/min]</td> </tr> <tr> <td>HUMID</td> <td>humidity @ humidity sensor [%rH]</td> </tr> <tr> <td>TEMP</td> <td>temperature @ humidity sensor [°C]</td> </tr> </table>	TIME	current time in seconds since 1904	P1;P2;P3;P4;P5	pressure sensor values [bar]	FLOW	flow sensor @ outlet [l/min]	MFC_SET	mass flow controller set [l/min]	MFC_READ	mass flow controller readout [l/min]	HUMID	humidity @ humidity sensor [%rH]	TEMP	temperature @ humidity sensor [°C]
TIME	current time in seconds since 1904														
P1;P2;P3;P4;P5	pressure sensor values [bar]														
FLOW	flow sensor @ outlet [l/min]														
MFC_SET	mass flow controller set [l/min]														
MFC_READ	mass flow controller readout [l/min]														
HUMID	humidity @ humidity sensor [%rH]														
TEMP	temperature @ humidity sensor [°C]														

Following commands for sampling start and stop are only applicable if a "Sam mode" event is running.

Sam mode commands	Description
START_batchID	start batch (example: <i>#start_123!</i> - start batch123)
START_PportID	start batch (example: <i>#start_p24!</i> - start batch of flask on port 24)
STOP_batchID	stop batch (example: <i>#start_123!</i> - stop batch123)
STOP_PportID	stop batch (example: <i>#stop_p24!</i> - stop batch of flask on port 24)

8.11. Advanced flow schemes

The “advanced flow schemes” tab appears only in “expert mode” (⇒ 8.8.2).

This tab allows defining time dependent flow transients. Times and flows are entered in table (2). You can import extensive self-made transients; an example file with possible number formats is available (4). The yellow transient (1) shows your wish while the green transient shows what will be done with the installed mass flow controllers (MFCs). The lower plot shows exchange volume or flask pressure depending on the chosen filling method. Installed MFCs and current cursor data are listed (3). Batch size, flask and tubing volume and start condition are hard defined and will be saved together with your transient in a common set (4). Be aware that the tubing volume on the front side is depending on the number of installed flasks. In “expert mode” you can choose the filling method “advanced flow scheme” in the sampling event schedule and assign your transient set to a scheduled sampling event (⇒ 8.2.2.).

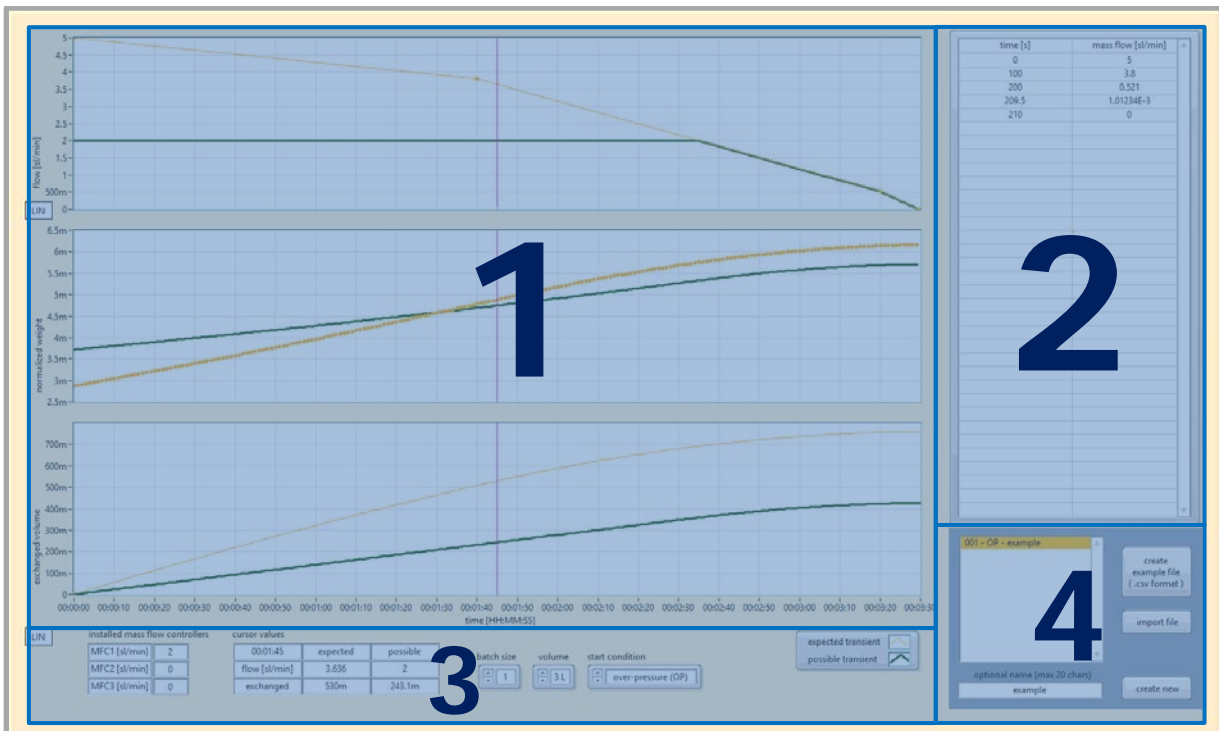

8.12. Time line plot

The time line plot is a help to survey scheduled events. Only events with a sufficient number of assigned flasks are shown. The graphs filling color distinguish overpressure (OP) and under-pressure (UP) sampling start conditions. The colors of the graph borders identify the event type. The graph length indicates for currently running (RUN), time triggered (TT) and leak test (LT) events the duration of the actual event and for analog/digital (A/D) and serial (SER) triggered events the duration of the scheduled trigger search as long as the event was not started.

The search for trigger signals will stop automatically when another event (i.e. sampling) starts or the punctual start of a scheduled time triggered sampling event is endangered. The time calculation includes preparation and sampling time for the trigger search event as well as the preparation time for the time triggered event. The trigger search will resume automatically after an interrupting event finished.

The "magnifier" control can be used to enlarge the duration of time triggered sampling events by a factor. It does not change the real sampling time, it is only an optical tool to ease the perception of i.e. 1h sampling events in 2 week intervals.

The "BLOCK" button indicates when the trigger search is suppressed i.e. when a sampling event is running. Pressing this button can be used for an early removal of a trigger search blockade that originates from a sampling with active "inhibit next sampling" option (⇒ 8.10).

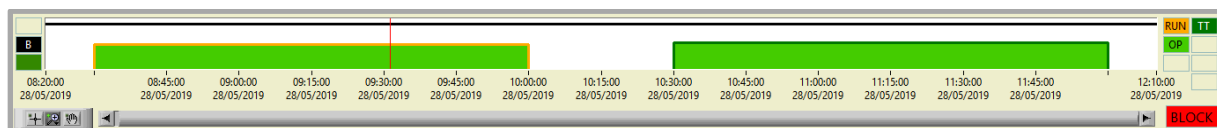

9. Filling methods

Air exchange (1/t flow) - flask content is exchanged with a time-weighted flow

start pressure: 1.6 bar(a)
 end pressure: 1.6 bar(a)

Air exchange (constant flow) - flask content is exchanged with over pressure at 1.6 bar with the specified exchange factor

start pressure: 1.6 bar(a)
 end pressure: 1.6 bar(a)

Flask fill with constant flow - an evacuated flask will be filled over the specified time with a constant flow. Only the front valve of the flask is opened to fill in the sample air. No air exchange takes place.

start pressure: $1 \cdot 10^{-3}$ bar(a)
 end pressure: 1.6 bar(a)

Advanced flow scheme - This method allows defining time dependent flow transients. All settings can be made in the "advanced flow scheme" tab ⇒ 8.11 (expert mode must be active ⇒ 8.8)

10. Sampling example

1. Insert flask(s) physically (⇒ 7.2)
2. Insert flask(s) in software (⇒ 7.3)
3. Wait for successful sampler self-test (⇒ 7.4)
4. Create sampling event (⇒ 8.2.2)
5. Wait till sampling event starts
6. Optionally view sampling procedure tab and sensor log tab (⇒ 8.3 and 8.4)
7. Wait till sampling event is finished
8. Use packing tool to remove the flasks (⇒ 8.4)
9. Remove flask(s) physically (⇒ 7.2)
10. Recapitulate sampling event in log view (⇒ 8.7)

11. Maintenance



Electric shock (before opening the device - pull main electricity plug)!
Opening the device may only be carried out by qualified personnel!



Repairs may only be carried out by the manufacturer or by qualified personnel!

These maintenance steps must be done within the specified period.

maintenance steps		every 2 years
1.	Check free movement of the flask port clips, if necessary use oil	X
2.	check the flat head screw on the clips (2.5 Nm)	X
3.	check smooth running of the gear wheels of each flask port and check the gear wheel screws (2,5 Nm)	X
4.	check smooth running of the valve motors and check the motor locking screw (2,5 Nm)	X
5.	Change O-rings of each flask port (⇒ 7.1)	X
6.	Check flexible tubing for kinks and abrasion	X
7.	Check drawer ratchet mechanism for free movement and proper function, replace if necessary	X
9.	Check if all screw connections are tighten	X
10.	Check pumps (see maintenance specifications of the manufacturer on the next page)	X

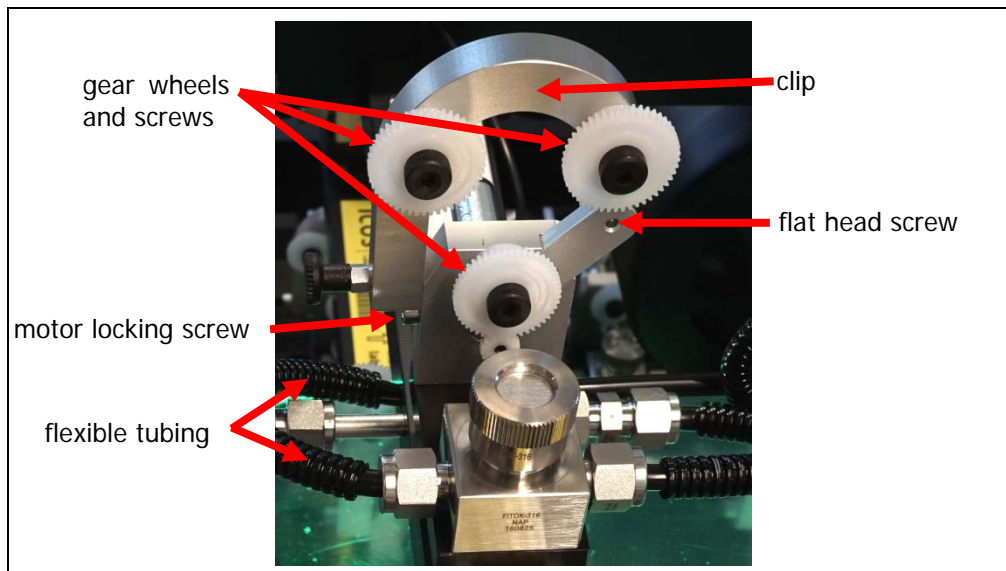

! Use thread locker for all screw connections (e.g. Loctite 243 - thread locker medium strength)!

KNF N 813.4 AN (under pressure pump)

Maintenance Specifications of the manufacturer¹:

Component	Servicing interval
Pump	Regular inspection for external damage or leaks
Hose connections	Regular inspection for external damage or leaks
Diaphragm and valve	Replace when pumping capacity decreases, or sooner

Air Dimensions J161-AF-HJ0 (over pressure pump)

Maintenance Specifications of the manufacturer²:

Component	Servicing interval
Diaphragms or Flapper Valve Gaskets	Replace when pumping capacity decreases
Diaphragm plate screws	Check if pump is rattling or knocking (Screw is under torqued)

Bronkhorst F-201CV-200-AAD-22-V (mass flow controller)

At normal use, no routine maintenance is required to be performed on the meters or controllers.³

¹ "KNF - Operating and Installation Instruction KNF N 813.4 AN" page 29 - 08/2014

² "Air Dimensions - Dia-Vac Pump Operating Instructions" page 4-5 - 2016

³ "Bronkhorst - General instructions digital Mass Flow / Pressure instruments..." page 29 – 02/2016

12. Troubleshooting

12.1. Frequent faults

Fault leak test / rapidly rising pressure in tubing (pressure sensors P4 and P5)	Check if flasks or blind plugs have been inserted at all ports
	Check if every connection is very tight
	Check if all flask valves are closed
	Check if sleeve / o-ring is existing (see 7.1) and in good / clean condition
	Use "Manual Control" to locate the leak (rear or front line)

12.2. Locate the leak

If the short leak test was not successfully, you can use the "plumbing overview" tab to locate the leak:

1. Push „Manual Control“ button to „ON“
2. Turn on vacuum pump, open Valve V3 and V7 and wait for one minute (all other valves should be closed)
3. Close V7 and then V3, turn off the vacuum pump
4. Check pressure sensors P5 (rear tubing) and P4 (front tubing)

The pressure of sensor P4 and P5 should not increase! Check the line with the increasing pressure. To locate the leak more precisely, you can swap all flasks piece by piece for blind plugs (or pieces of two or three).

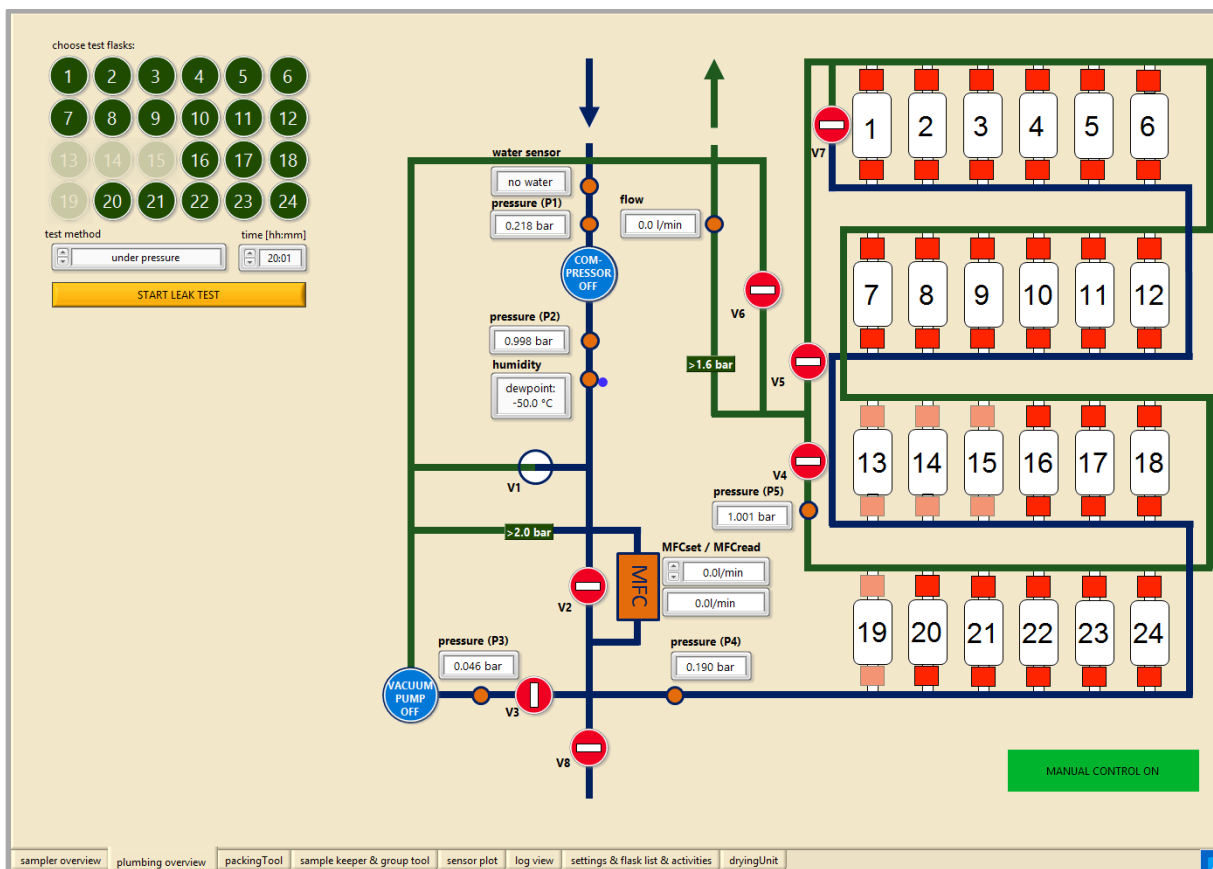

13. Spare part list / consumables

spare part name	item number	supplier
O-rings 1/2" (Ultratorr-Fitting) 	VI7-014	Fitok / HPS Solutions www.hps-solutions.de
stainless steel sleeve (Ultratorr-Fitting) 	SS-SL-VL8	
Filter 7 mikron 	FWSS-FL4-S-7	
Pumpe IP44-T 230V50Hz N813.4 ANE	024708/024736	KNF Neuberger GmbH www.knf.com
Diaphragm, o-rings and valve seal for the vacuum pump, (Spare parts set NB1 3.OAN)	032494 (2 sets are required for one pump)	
MACRO PUMP 24V DC VITON/TEF	J161-AF-HJ0	ADI - Air Dimensions Incorporated www.airdimensions.com
Diaphragm KIT, REPAIR MACRO TEF/VITON	11706	

14. Contact

Flask and Calibration Laboratory (FCL)
Integrated Carbon Observation System (ICOS)
Max-Planck-Institute for Biogeochemistry
Kahlaische Straße 4
D-07745 Jena
Germany
flasksampler@bgc-jena.mpg.de
<http://www.icos-cal.eu/fcl>

APPENDIX

I. Color coding drawer front

color drawer closed	Description
green	no problems - sampler ready
red	problem occurred - user action required
blue	automated procedure running





color drawer open	Description
yellow	drawer open
cyan	barcode scanner mount mode
purple	barcode scanner unmount mode
red-yellow blinking	several drawers open or drawer open while procedure running → <i>close drawer immediately!</i>

II. Blink coding

color drawer closed	Description
green 1x 1.5s	sampler self-test - pressure okay
red 1x 1.5s	sampler self-test - pressure to high

color drawer open	Description
green 1x 120ms	port acknowledged
green 2x 120ms	mount mode – flask mounted
red 1x 150ms	mount mode – flask port already occupied
red 2x 150ms	mount mode – flask already mounted
red 3x 150ms	mount mode – flask open
red 4x 150ms	mount mode – flask not registered
green 2x 200ms	unmount mode – flask unmounted
red 3x 200ms	unmount mode – no flask to unmount at port

III. Barcodes

Function	ASCII character	Barcode (CODE128)
mount flask mode	MFLSK	 mount flask
unmount flask mode	UFLSK	 unmount flask
assign port	P01 - P24	 01  24
Scan Mode = Trigger Single	-	